

Data Sheet

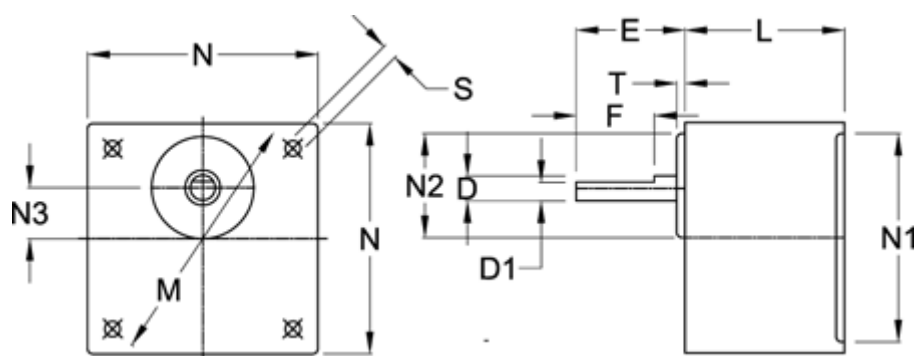

Article number: 72006009022
Description: Gear Head SG9B I=9
Pinion input

Measures



D = 8	N2 = 24
D1 = 7	N3 = 10
E = 32	S = 4x \varnothing 4,5
F = 12	T = 3
L = 30	
M = 70	
N = 60	
N1 = -	